

## air distributors with airflow balancing system

2nd generation ventilation air distribution system. 1st on the market.

IPX-PREMIUM by Inwest-Produkt is a complete hybrid air distributor ventilation system equipped with specially developed connectors for corrugated flexible ducts. These connectors are made of a specially developed mix of materials which is **weatherproof** with UV protection, **flexible** even in low temperature, with high resistance to many chemical agents. No odor, no-ageing, recyclable. **Compatible** with most corrugated pipes on market.

The IPX-PREMIUM connectors are **structurally equipped with 2 gaskets built-in**, thanks to this they are self-sealing and do not require the use of additional gaskets for the pipe. The system has **high tightness class** and provide easy and quick mounting. System is available in **4 diameters**: Ø50, Ø63, Ø75 and Ø90mm. Boxes and distributors are made of steel with **high density zinc layer** (275 g/m<sup>2</sup>) and they have many innovative solutions. Their steel connectors have additional sealing between box body and connector for **extra tightness**.

All 2-row air-distributors are **openable** for inspections and equipped with **perforated plate** that makes **airflow balanced**. Air distributor boxes may be insulated inside / outside or inside and outside with **insulation** that have protection against the growth of fungi and bacteria. IPX-PREMIUM system ensures low airflow resistance, which ensures **low energy consumption**.



**inwestprodukt**  
creating future

SHORT CONNECTOR AIR BOXES

IPSX

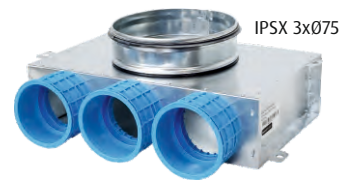

Ød [mm]	Ø50	Ø63	Ø75	Ø90
IPSX 1xØd / Ø100	17,00 €	17,00 €	17,00 €	22,00 €
IPSX 1xØd / Ø125	19,00 €	19,00 €	19,00 €	23,00 €
IPSX 2xØd / Ø125	20,00 €	20,00 €	20,00 €	26,00 €
IPSX 3xØd / Ø125	23,00 €	23,00 €	23,00 €	26,00 €
IPSX 3xØd / Ø160	26,00 €	26,00 €	26,00 €	28,00 €
IPSX 4xØd / Ø160	28,00 €	28,00 €	28,00 €	31,00 €
H [mm]	56	72	82	102

LONG CONNECTOR AIR BOXES

IPSXD

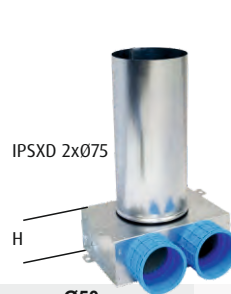

	Ø50	Ø63	Ø75	Ø90
IPSXD / IPSXD <sub>PVC</sub> 1xØd / Ø100	19,00 €	19,00 €	19,00 €	24,00 €
IPSXD / IPSXD <sub>PVC</sub> 1xØd / Ø125	21,00 €	21,00 €	21,00 €	27,00 €
IPSXD / IPSXD <sub>PVC</sub> 2xØd / Ø125	21,00 €	21,00 €	21,00 €	28,00 €
IPSXD / IPSXD <sub>PVC</sub> 3xØd / Ø125	25,00 €	25,00 €	25,00 €	30,00 €
IPSXD 3xØd / Ø160	28,00 €	28,00 €	28,00 €	31,00 €
IPSXD 4xØd / Ø160	31,00 €	31,00 €	31,00 €	34,00 €
H [mm]	56	72	82	102

IPSXD<sub>PVC</sub> - air valve connector made of PVC duct, L=300mm

PLASTERBOARD AIR BOXES

IPSX-GK

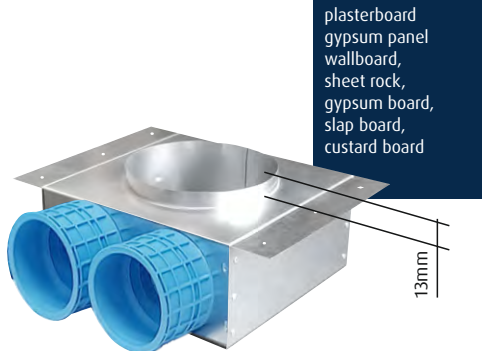

plasterboard  
gypsum panel  
wallboard,  
sheet rock,  
gypsum board,  
slap board,  
custard board

13mm

AIR BOXES FOR BUILDINGS IN DRYWALL OR CANADIAN SYSTEM

For wall mounting in drywall or frame buildings, use special boxes.

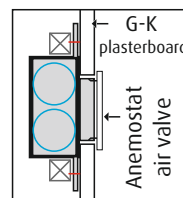
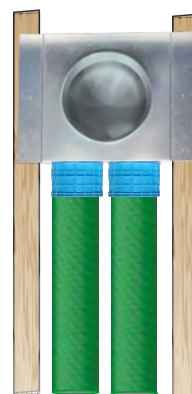

top view

A practical solution for applications in Canadian type construction. Wide fixings make it easy to install air box. Very short the air valve connector (13mm). Adapted to the thickness of plasterboards.

	Ø50	Ø63	Ø75	Ø90
IPSX-GK 1xØd / Ø100	22,00 €	22,00 €	22,00 €	27,00 €
IPSX-GK 1xØd / Ø125	24,00 €	24,00 €	24,00 €	30,00 €
IPSX-GK 2xØd / Ø125	24,00 €	24,00 €	24,00 €	31,00 €
IPSX-GK 3xØd / Ø125	28,00 €	28,00 €	28,00 €	33,00 €
IPSX-GK 3xØd / Ø160	31,00 €	31,00 €	31,00 €	34,00 €
IPSX-GK 4xØd / Ø160	34,00 €	34,00 €	34,00 €	37,00 €

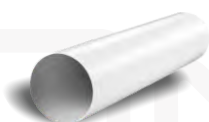

ØD [mm]	Ø100	Ø125
PVC DUCT for air boxes, length=1,0m	4,70 €	6,00 €

ANGLE FLOW AIR DISTRIBUTORS LR

IPRKX-LR



[UNIVERSAL LEFT OR RIGHT]



	Ø50	Ø63	Ø75	Ø90
IPRKX Ø160 /6x Ød - LR	67,00 €	67,00 €	67,00 €	77,00 €
IPRKX Ø160 /6x Ød - IZOLw* - LR	82,00 €	82,00 €	82,00 €	95,00 €
IPRKX Ø160 /8x Ød - LR	77,00 €	77,00 €	77,00 €	85,00 €
IPRKX Ø160 /8x Ød - IZOLw* - LR	94,00 €	94,00 €	94,00 €	105,00 €
IPRKX Ø160 /10x Ød - LR	85,00 €	85,00 €	85,00 €	97,00 €
IPRKX Ø160 /10x Ød - IZOLw* - LR	102,00 €	102,00 €	102,00 €	117,00 €
IPRKX Ø200 /10x Ød - LR	99,00 €	99,00 €	99,00 €	108,00 €
IPRKX Ø200 /10x Ød - IZOLw* - LR	118,00 €	118,00 €	118,00 €	121,00 €

2-ROW THRU FLOW AIR DISTRIBUTORS

IPRPDX

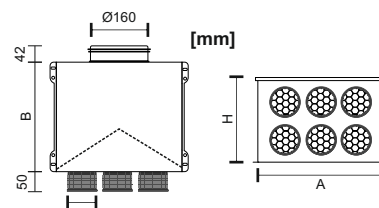

	Ø50	Ø63	Ø75	Ø90
IPRPDX Ø160 /6x Ød	73,00 €	73,00 €	73,00 €	83,00 €
IPRPDX Ø160 /6x Ød - IZOLw*	94,00 €	94,00 €	94,00 €	107,00 €
IPRPDX Ø160 /6x Ød - IZOLw/z*	111,00 €	111,00 €	111,00 €	125,00 €
IPRPDX Ø160 /8x Ød	80,00 €	80,00 €	80,00 €	90,00 €
IPRPDX Ø160 /8x Ød - IZOLw*	99,00 €	99,00 €	99,00 €	114,00 €
IPRPDX Ø160 /8x Ød - IZOLw/z*	117,00 €	117,00 €	117,00 €	134,00 €
IPRPDX Ø200 /10x Ød	91,00 €	91,00 €	91,00 €	102,00 €
IPRPDX Ø200 /10x Ød - IZOLw*	114,00 €	114,00 €	114,00 €	131,00 €
IPRPDX Ø200 /10x Ød - IZOLw/z*	131,00 €	131,00 €	131,00 €	148,00 €
IPRPDX Ø200 /12x Ød	97,00 €	97,00 €	97,00 €	110,00 €
IPRPDX Ø200 /12x Ød - IZOLw*	120,00 €	120,00 €	120,00 €	137,00 €
IPRPDX Ø200 /12x Ød - IZOLw/z*	137,00 €	137,00 €	137,00 €	156,00 €

IZOLw - inner insulation 10mm . IZOLw/z - inner and outer insulation 10mm/10mm.

1-ROW ANGLE FLOW AIR DISTRIBUTORS

IPRKJX

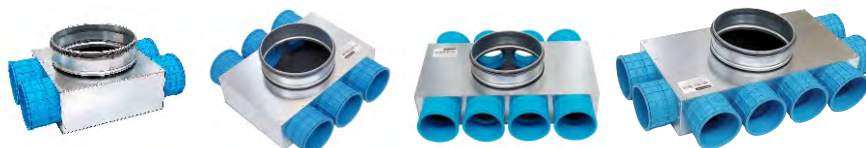

IPRKJX Ø160 / 4x Ø75 (0202) IPRKJX Ø160 / 6x Ø75 (0303) IPRKJX Ø160 / 8x Ø75 (0404) IPRKJS Ø160 / 8x Ø75 (2420)

	Ø50	Ø63	Ø75	Ø90
IPRKJX Ø160 /4x Ød (0202)	40,00 €	40,00 €	40,00 €	46,00 €
IPRKJX Ø160 /4x Ød (0202) - IZOLw*	56,00 €	56,00 €	56,00 €	62,00 €
IPRKJX Ø160 /6x Ød (0303)	51,00 €	51,00 €	51,00 €	57,00 €
IPRKJX Ø160 /6x Ød (0303) - IZOLw*	67,00 €	67,00 €	67,00 €	78,00 €
IPRKJX Ø160 /8x Ød (0404)	66,00 €	66,00 €	66,00 €	74,00 €
IPRKJX Ø160 /8x Ød (0404) - IZOLw*	80,00 €	80,00 €	80,00 €	91,00 €
IPRKJX Ø160 /8x Ød (2420)	66,00 €	66,00 €	66,00 €	74,00 €
IPRKJX Ø160 /8x Ød (2420) - IZOLw*	80,00 €	80,00 €	80,00 €	91,00 €
H [mm]	56	72	82	102

IZOLw - inner insulation 3mm made of rubber with closed cells. IZOLw/z - inner 10mm & outer 10mm insulation made of rubber with closed cells.

IP STANDARD version (steel connectors Ø63, Ø75, Ø90 ) and IP PLUS version (rubber connectors Ø50, Ø63, Ø75, Ø90) - prices are the same as IPX-PREMIUM version.



\* Insulation products have protection against the growth of fungi and bacteria. The products have a hygiene certificate that allows their use in the food industry.







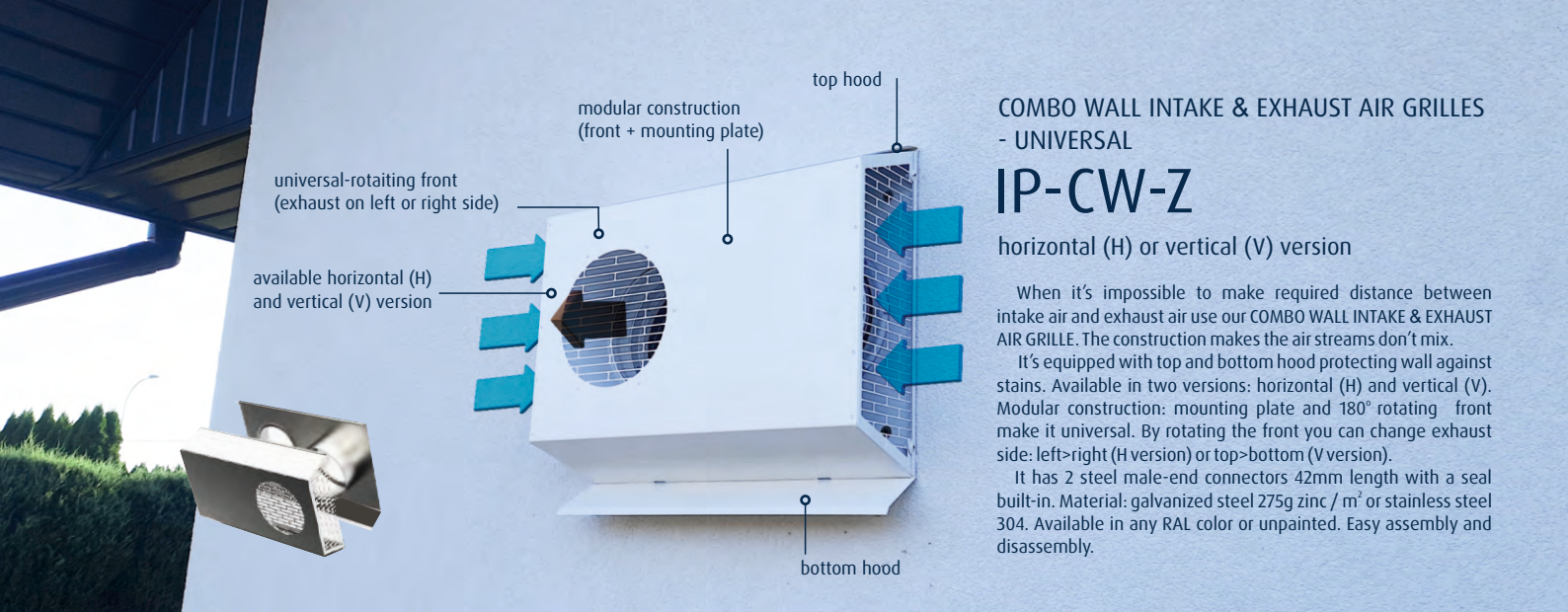

## COMBO WALL INTAKE & EXHAUST AIR GRILLES - UNIVERSAL

# IP-CW-Z

horizontal (H) or vertical (V) version

When it's impossible to make required distance between intake air and exhaust air use our COMBO WALL INTAKE & EXHAUST AIR GRILLE. The construction makes the air streams don't mix.





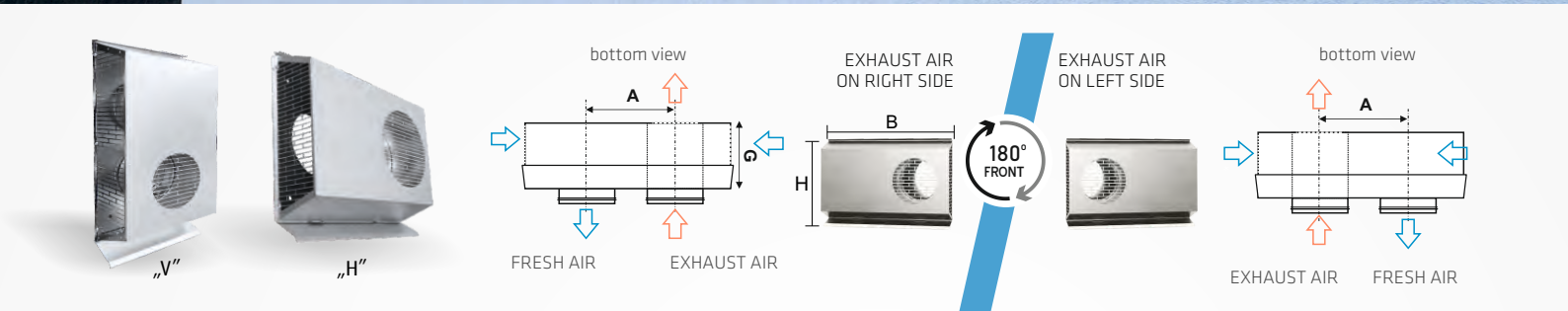





It's equipped with top and bottom hood protecting wall against stains. Available in two versions: horizontal (H) and vertical (V). Modular construction: mounting plate and 180° rotating front make it universal. By rotating the front you can change exhaust side: left-right (H version) or top-bottom (V version).

It has 2 steel male-end connectors 42mm length with a seal built-in. Material: galvanized steel 275g zinc / m<sup>2</sup> or stainless steel 304. Available in any RAL color or unpainted. Easy assembly and disassembly.

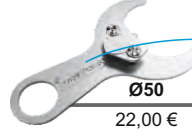

ØD [mm]	Ø160	Ø200	Ø250	Ø315
IP CW-Z H / V [zinc]	165,00 €	170,00 €	185,00 €	165,00 €
IP CW-Z H / V [RAL]	199,00 €	220,00 €	225,00 €	200,00 €
IP CW-Z H / V [stainless steel]	⌚	⌚	⌚	⌚
Dimension AxBxHxG [mm]	215x480x435x145	255x560x495x145	350x680x605x160	412x795x605x160

## Accessories

 <p><b>Rubber insulation sleeve with closed cells 13mm/2m</b></p> <table border="1"> <thead> <tr> <th></th> <th>Ø63</th> <th>Ø75</th> <th>Ø90</th> </tr> </thead> <tbody> <tr> <td>Price/pcs (2m)</td> <td>7,90 €</td> <td>9,60 €</td> <td>11,50 €</td> </tr> <tr> <td>Price/1m</td> <td>3,90 €</td> <td>4,80 €</td> <td>5,70 €</td> </tr> </tbody> </table>		Ø63	Ø75	Ø90	Price/pcs (2m)	7,90 €	9,60 €	11,50 €	Price/1m	3,90 €	4,80 €	5,70 €	 <p><b>Insulation sleeve 10m / Ø100.</b> Price / 10m</p> <p>Outer shell: flame retardant polyester. Insulation thickness: 25mm or 50mm.</p> <table border="1"> <thead> <tr> <th>Insulation thickness</th> <th>25mm</th> <th>50mm</th> </tr> </thead> <tbody> <tr> <td>Ø50 / Ø63 / Ø75 / Ø90</td> <td>39,00 €</td> <td>54,00 €</td> </tr> </tbody> </table>	Insulation thickness	25mm	50mm	Ø50 / Ø63 / Ø75 / Ø90	39,00 €	54,00 €																												
	Ø63	Ø75	Ø90																																												
Price/pcs (2m)	7,90 €	9,60 €	11,50 €																																												
Price/1m	3,90 €	4,80 €	5,70 €																																												
Insulation thickness	25mm	50mm																																													
Ø50 / Ø63 / Ø75 / Ø90	39,00 €	54,00 €																																													
 <p><b>In-line ducts connector</b> Price / pcs</p> <p>IPMF-SU - self-sealing. <u>No extra gaskets on pipe needed.</u> IPMF - plastic connector. <u>Extra gasket on pipe needed</u></p> <table border="1"> <thead> <tr> <th></th> <th>Ø50</th> <th>Ø63</th> <th>Ø75</th> <th>Ø90</th> </tr> </thead> <tbody> <tr> <td>IPMF</td> <td>2,20€</td> <td>2,20€</td> <td>2,50€</td> <td>2,70€</td> </tr> <tr> <td>IPMF-SU</td> <td>-</td> <td>-</td> <td>2,40€</td> <td>-</td> </tr> </tbody> </table>		Ø50	Ø63	Ø75	Ø90	IPMF	2,20€	2,20€	2,50€	2,70€	IPMF-SU	-	-	2,40€	-	 <p><b>GASKET ring with talc</b> Price / pcs</p> <table border="1"> <thead> <tr> <th></th> <th>Ø50</th> <th>Ø63</th> <th>Ø75</th> <th>Ø90</th> </tr> </thead> <tbody> <tr> <td></td> <td>0,70 €</td> <td>0,80 €</td> <td>0,95 €</td> <td>1,10 €</td> </tr> </tbody> </table>		Ø50	Ø63	Ø75	Ø90		0,70 €	0,80 €	0,95 €	1,10 €																					
	Ø50	Ø63	Ø75	Ø90																																											
IPMF	2,20€	2,20€	2,50€	2,70€																																											
IPMF-SU	-	-	2,40€	-																																											
	Ø50	Ø63	Ø75	Ø90																																											
	0,70 €	0,80 €	0,95 €	1,10 €																																											
 <p><b>PLUGS</b> Price / pcs</p> <table border="1"> <thead> <tr> <th></th> <th>Ø50</th> <th>Ø63</th> <th>Ø75</th> <th>Ø90</th> </tr> </thead> <tbody> <tr> <td>1</td> <td>1,00 €</td> <td>1,00 €</td> <td>1,00 €</td> <td>1,00 €</td> </tr> <tr> <td>2</td> <td>Ø50 - Ø90</td> <td>Ø100</td> <td>Ø125</td> <td>Ø160</td> <td>Ø200</td> </tr> <tr> <td></td> <td>1,00 €</td> <td>1,20 €</td> <td>1,60 €</td> <td>2,20 €</td> <td>4,00 €</td> </tr> </tbody> </table>		Ø50	Ø63	Ø75	Ø90	1	1,00 €	1,00 €	1,00 €	1,00 €	2	Ø50 - Ø90	Ø100	Ø125	Ø160	Ø200		1,00 €	1,20 €	1,60 €	2,20 €	4,00 €	 <p><b>UNI AIR VALVE</b> Price / pcs</p> <table border="1"> <thead> <tr> <th></th> <th>UNI EFF (wywiewny) (extract)</th> <th>UNI TFF (nawiewny) (supply)</th> <th>Ø80</th> <th>Ø100</th> <th>Ø125</th> <th>Ø160</th> <th>Ø200</th> </tr> </thead> <tbody> <tr> <td>UNI EFF</td> <td>5,40 €</td> <td>6,50 €</td> <td>9,50 €</td> <td>12,00 €</td> <td>15,40 €</td> <td></td> <td></td> </tr> <tr> <td>UNI TFF</td> <td>6,70 €</td> <td>7,60 €</td> <td>10,30 €</td> <td>15,00 €</td> <td>19,00 €</td> <td></td> <td></td> </tr> </tbody> </table>		UNI EFF (wywiewny) (extract)	UNI TFF (nawiewny) (supply)	Ø80	Ø100	Ø125	Ø160	Ø200	UNI EFF	5,40 €	6,50 €	9,50 €	12,00 €	15,40 €			UNI TFF	6,70 €	7,60 €	10,30 €	15,00 €	19,00 €		
	Ø50	Ø63	Ø75	Ø90																																											
1	1,00 €	1,00 €	1,00 €	1,00 €																																											
2	Ø50 - Ø90	Ø100	Ø125	Ø160	Ø200																																										
	1,00 €	1,20 €	1,60 €	2,20 €	4,00 €																																										
	UNI EFF (wywiewny) (extract)	UNI TFF (nawiewny) (supply)	Ø80	Ø100	Ø125	Ø160	Ø200																																								
UNI EFF	5,40 €	6,50 €	9,50 €	12,00 €	15,40 €																																										
UNI TFF	6,70 €	7,60 €	10,30 €	15,00 €	19,00 €																																										
 <p><b>CORRUGATED DUCT CUTTER</b> Price / pcs</p> <p>CUSTOMIZE CUTTER Your logo on one-time order over 100pcs.</p> <table border="1"> <thead> <tr> <th></th> <th>Ø50</th> <th>Ø63</th> <th>Ø75</th> <th>Ø90</th> </tr> </thead> <tbody> <tr> <td></td> <td>22,00 €</td> <td>22,00 €</td> <td>22,00 €</td> <td>24,00 €</td> </tr> </tbody> </table>		Ø50	Ø63	Ø75	Ø90		22,00 €	22,00 €	22,00 €	24,00 €	 <p><b>GLIDE PRO - lubricating and preserving spray</b> Price / pcs</p> <table border="1"> <thead> <tr> <th></th> <th>400ml</th> </tr> </thead> <tbody> <tr> <td>Glide Pro spray</td> <td>11,00 €</td> </tr> </tbody> </table>		400ml	Glide Pro spray	11,00 €																																
	Ø50	Ø63	Ø75	Ø90																																											
	22,00 €	22,00 €	22,00 €	24,00 €																																											
	400ml																																														
Glide Pro spray	11,00 €																																														
 <p><b>8 PIPES HOLDER (=1pcs)</b> Price / pcs</p> <table border="1"> <thead> <tr> <th></th> <th>Ø50</th> <th>Ø63</th> <th>Ø75</th> <th>Ø90</th> </tr> </thead> <tbody> <tr> <td></td> <td>7,50 €</td> <td>7,50 €</td> <td>7,50 €</td> <td>9,00 €</td> </tr> </tbody> </table>		Ø50	Ø63	Ø75	Ø90		7,50 €	7,50 €	7,50 €	9,00 €	 <p><b>90 degree 4 DUCTS CONNECTOR</b> Price / pcs</p> <table border="1"> <thead> <tr> <th></th> <th>Ø50</th> <th>Ø63</th> <th>Ø75</th> <th>Ø90</th> </tr> </thead> <tbody> <tr> <td></td> <td>79,00 €</td> <td>79,00 €</td> <td>79,00 €</td> <td>92,00 €</td> </tr> </tbody> </table>		Ø50	Ø63	Ø75	Ø90		79,00 €	79,00 €	79,00 €	92,00 €																										
	Ø50	Ø63	Ø75	Ø90																																											
	7,50 €	7,50 €	7,50 €	9,00 €																																											
	Ø50	Ø63	Ø75	Ø90																																											
	79,00 €	79,00 €	79,00 €	92,00 €																																											



**invest**produkt  
creating future

Inwest-Klima  
M.Godlewski, E.Hankowska Sp.J.



ul. Przędzalniana 8  
15-688 Białystok, Poland



+ 48 85 662 24 64



[www.inwestklima.com.pl](http://www.inwestklima.com.pl)  
[biuro@investklima.com.pl](mailto:biuro@investklima.com.pl)